



FIRST® IN SHOWSM
presented by Qualcomm

firstinspires.org/robotics/ftc

2023-2024 *FIRST*® Tech Challenge

Robot Wiring Guide

Sponsor Thank You

Thank you to our generous sponsor for your continued support of the *FIRST*® Tech Challenge!



Raytheon Technologies

Introduction

What is FIRST® Tech Challenge?

FIRST® Tech Challenge is a student-centered program that focuses on giving students a unique and stimulating experience. Each year, teams engage in a new game where they design, build, test, and program autonomous and driver operated robots that must perform a series of tasks. To learn more about *FIRST*® Tech Challenge and other *FIRST*® Programs, visit www.firstinspires.org.

Gracious Professionalism®

FIRST® uses this term to describe our programs' intent.

Gracious Professionalism® is a way of doing things that encourages high-quality work, emphasizes the value of others, and respects individuals and the community.

Watch Dr. Woodie Flowers explain *Gracious Professionalism* in this [short video](#).

Revision History		
Revision	Date	Description
1	7/25/2023	Initial Release

Contents

Introduction.....	3
<i>What is FIRST® Tech Challenge?</i>	3
<i>Gracious Professionalism®</i>	3
Contents.....	4
Introduction to Robot Wiring	6
1. Best Practices	7
1.1. <i>Appropriate Tools</i>	7
1.2. <i>Strain Relief</i>	9
1.3. <i>Securing Wires and Connectors</i>	10
1.4. <i>Wire Management</i>	14
1.5. <i>Wires on Moving Parts</i>	15
1.6. <i>Battery Security</i>	16
1.7. <i>Battery Safety</i>	17
1.8. <i>12V Power Switch</i>	18
1.9. <i>12V Power Distribution</i>	19
1.10. <i>Protective Side Shields</i>	19
1.11. <i>Wi-Fi Considerations</i>	21
1.12. <i>ESD Mitigation</i>	22
1.12.1. <i>Grounding</i>	22
1.12.2. <i>Ferrite Choke</i>	23
1.12.3. <i>Placement of Wires</i>	24
1.12.4. <i>Avoid External Exposed Metal</i>	25
1.12.5. <i>Wheel Considerations</i>	25
1.13. <i>Driver Station</i>	26
2. Adapting Power Systems.....	27
2.1. <i>Types of Wires and Connectors</i>	27
2.2. <i>Making an Adapter</i>	28
2.3. <i>Installing Anderson PowerPoles</i>	28
3. Adapting Logic Levels.....	30
3.1. <i>Level Shifters</i>	30
4. Common Problems and Troubleshooting:.....	31

4.1. Connection Issues.....	31
4.2. Hub and Phone Communication Issues	32
5. Additional Resources	32
Appendix A – Resources	33
Game Forum Q&A	33
Volunteer Forum	33
FIRST Tech Challenge Game Manuals.....	33
FIRST Headquarters Pre-Event Support.....	33
FIRST Websites.....	33
FIRST Tech Challenge Social Media	33
Feedback.....	33

Introduction to Robot Wiring

The wiring of a robot serves two primary purposes. The first purpose is to provide electrical power to the devices on a robot. The second purpose is to provide a communication network for the many devices that make up a robot's control system.

Here is a list of items that will improve security and organization of the wiring system. Items highlighted in **orange** are recommended for best performance, but items highlighted in **blue** are suggested. These are not included in the FTC (FIRST Tech Challenge) Kit of Parts.

Item	Source	Part No.	Cost	QTY
Grounding wire	Resistive Grounding Strap	REV-31-1269	\$4.00	1
Ferrite chokes	Ferrite Cable Clips	REV-39-1224	\$2.00	4
Spiral wire sheath	Spiral Sleeving	7378K43	\$6.00	10 ft.
XT30 Power Distribution Hub	XT30 Power Distribution Block	REV-31-1293	\$10.00	1
Rubber Grommets	Grommet Assortments	9600K25	\$7.00	100
Velcro	Hook and Loop Fasteners	94985K41	\$2.00	per ft.
3M Dual Lock	Snap-Together Fastners	94935K17	\$3.65	per ft.
Total			\$62.65	

Teams should follow best practices when wiring their robots. This will help to ensure that the placement, connections, and security of their wires will lead to improved robot performance, eliminate intermittent electrical problems, and allow for easy troubleshooting and resolution of electrical and/or signal-related problems.

Important note: Keep in mind, if you redesign the footprint of your robot to leave enough space for the wiring required.

This guide shows the basics of properly wiring a robot, how to improve wiring reliability, and how to handle hardware issues associated with wiring.

As always, the [FTC Q&A Forum](#) and [Game Manual](#) rules take precedence over recommendations made here. Please refer to these sources before embarking on the electrical wiring task.

NOTE: This guide primarily uses the REV Robotics Expansion Hub in its examples, but the guidelines apply equally well to the REV Robotics Control Hub. These Hubs provide electronic *input/output* (or "I/O") ports that are used to "talk" to a robot's motors, servos, and sensors. The layout of I/O ports is the same for both the Expansion Hub and Control Hub.

NOTE: One of the important differences between the Expansion Hub and the Control Hub is the external Android device used with Expansion Hub and the internal Android device used within the Control Hub to accomplish the same task of wireless communication with the driver station.

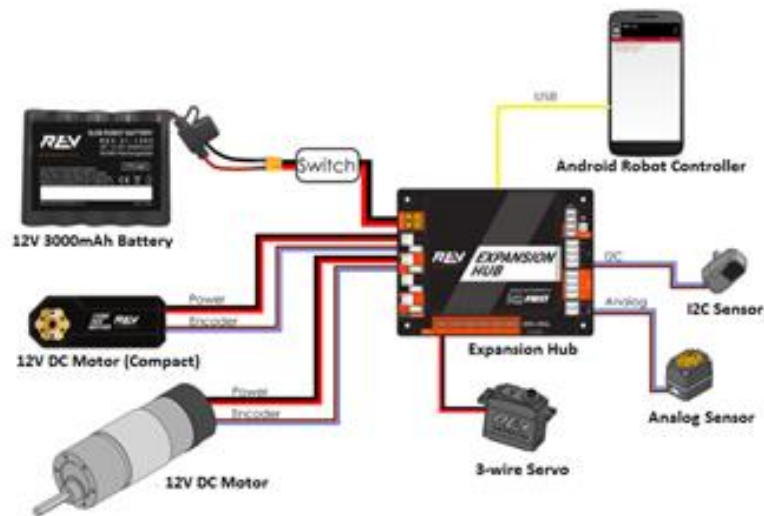

Figure 1: Expansion Hub Configuration

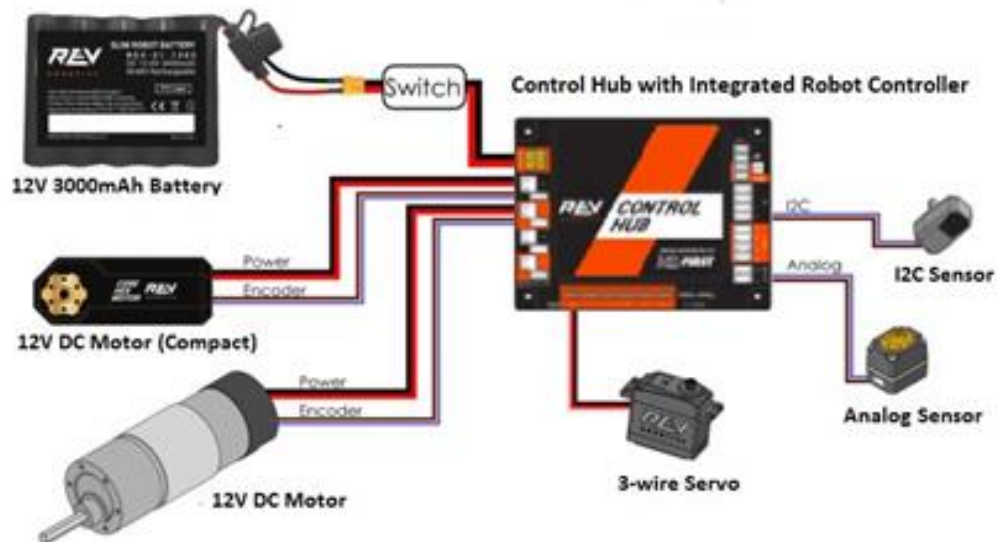

Figure 2: Control Hub Configuration

1. Best Practices

1.1. Appropriate Tools

Using the correct tools will make wiring tasks easier, and the result is more reliable.

If you are not making your own custom cables and connectors, the only tool you might need is a small pair of wire snippers or diagonal cutters. These are useful for trimming zip ties. Poorly trimmed zip ties present a sharp point and can be a hazard.

Gracious Professionalism® - "Doing your best work while treating others with respect and kindness - It's what makes FIRST, first."

When changing or remaking crimped connections, you will need a pair of wire strippers and possibly a dedicated crimping tool. Wire strippers allow you to strip the insulation off different wire gauges while ensuring that none of the copper strands are cut. Generic crimping tools are suitable for common spade lugs, but for custom connectors (like the Anderson Power Poles) a dedicated crimper may be required.

When shortening or extending wires, or when making a power distribution bus, a soldering iron and heat gun are useful tools. For electronics work, a temperature-controlled iron is recommended, and a small heat gun can be used for typical diameter heat shrink.

When running multiple wires (like several servo wires), it can be a future time-saver to apply simple labels to wires at the point where they plug in. These can be as simple as pieces of tape folded over the wire and named with a sharpie.



Figure 5: Wire Snippers



Figure 3: Small Nippers for cutting zip ties



Figure 6: Ferrule Crimpers



Figure 8: Needle Nose Pliers



Figure 7: Anderson Power Pole Crimpers



Figure 9: Heat Gun for Shrink wrap insulation



Figure 10: Temperature Controller Soldering Iron/station

1.2. Strain Relief

Strain relieving is the technique used to reduce the amount of stress at a wire connection. In our case, this connection is typically a two-part connector. Proper strain relief will prevent the connector from becoming unplugged, or from having the wires break loose from the connector itself. In general, all connections should be properly strain relieved.

Immobilize the wire an inch or two from the connector and leave a little slack on the connector side. This prevents unintended tension on the wire from damaging the connector and allows the connector to be unplugged, if desired, for testing or module replacement. This can easily be done with a few zip ties. It may be acceptable to mount the connector more rigidly, but only if all parts involved are also mounted solidly on a rigid panel.

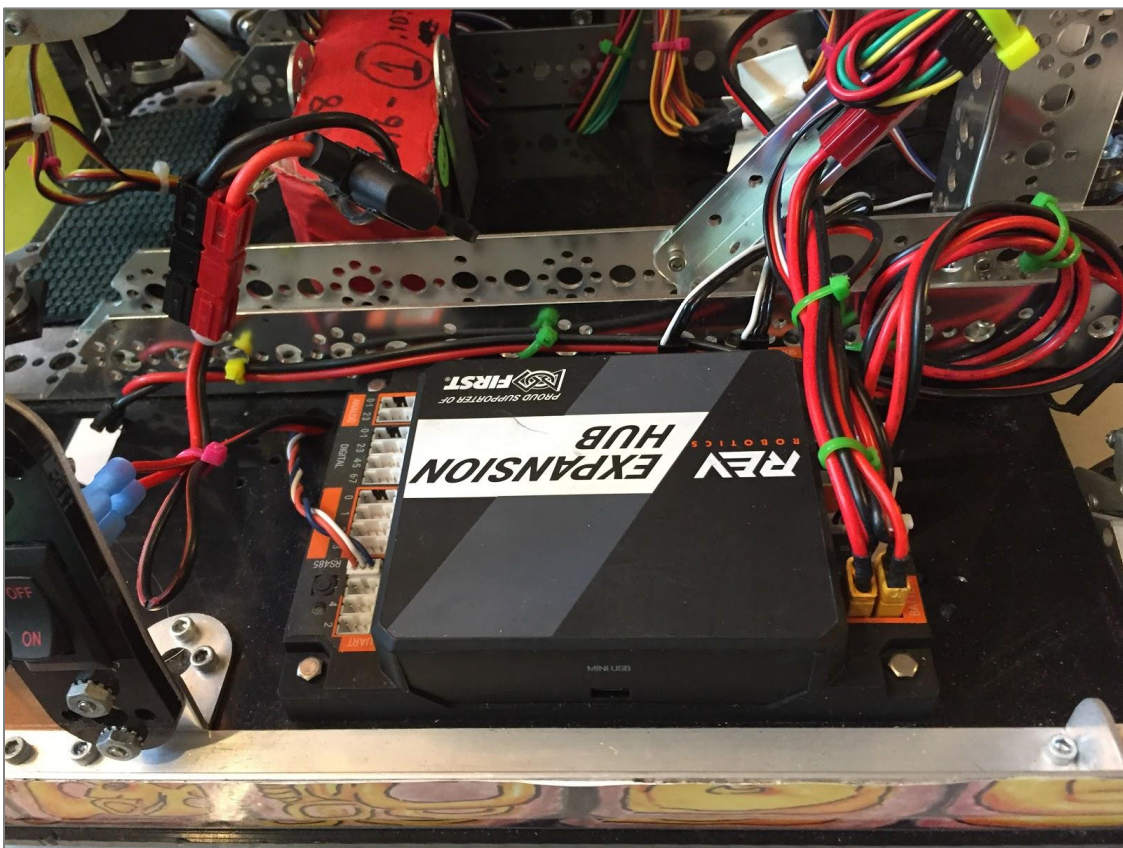

Figure 11: Strain Relief and Wire Restraints

- A. Channel with zip ties.
- B. Wires are also bundled based on their destination, such as motors, and then neatly coiled.
- C. The 12V battery is held in place by a metal TETRIX bracket and Velcro (under battery), and the main power connector is also constrained to the c-channel. The power switch is mounted in an easily accessible location, which will be protected behind a side shield with a finger hole.
- D. The REV Expansion Hub is mounted to a plastic base, which extends $\frac{1}{8}$ " beyond the metal chassis to minimize ESD (electrostatic discharge).

NOTE: Every wire connection is a possible point of failure. This applies to all electronics.

1.3. Securing Wires and Connectors

In general, all wires should be properly secured.

Properly securing wiring will:

- Minimize connection errors with the Android phone.
- Prevent wires from moving into pinch points (e.g., between two gears or into a movable mechanism).
- Prevent entanglement with field elements and other robots.
- Provide easier access for maintenance.
- Prevent strain on wiring components.

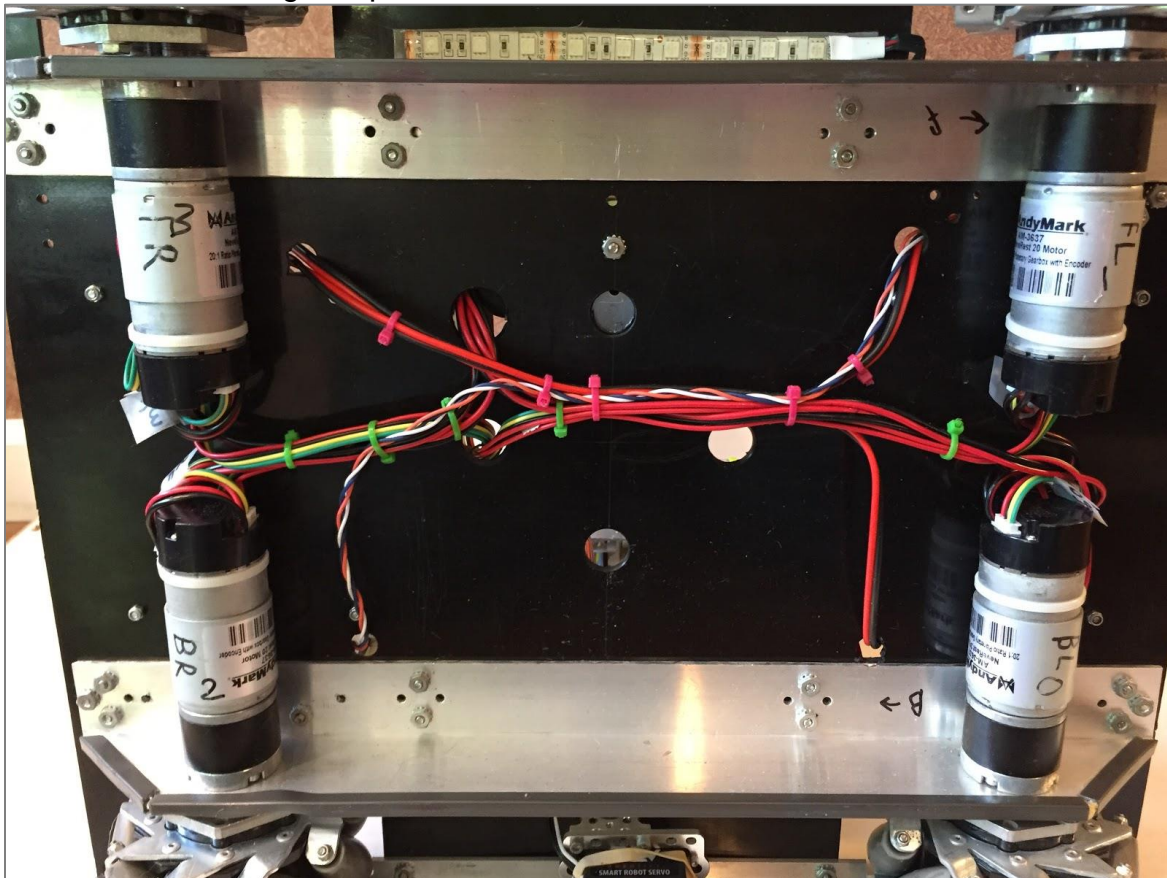

Figure 12: Securing Wires

- The power and encoder wires for this drive train are strain relieved at the motors themselves
- Secured to each other and to the plastic chassis baseplate.
- The metallic chassis beams are insulated with plastic strips to prevent electrostatic discharges as the robot rolls off its metal platform.

Wires should be tied down (secured) at regular intervals to prevent them from moving or shaking loose during a match. It is best to run wires along stationary parts of a robot. Zip ties offer a sturdy way to secure wires, but electrical tape or Velcro® straps can also be used.

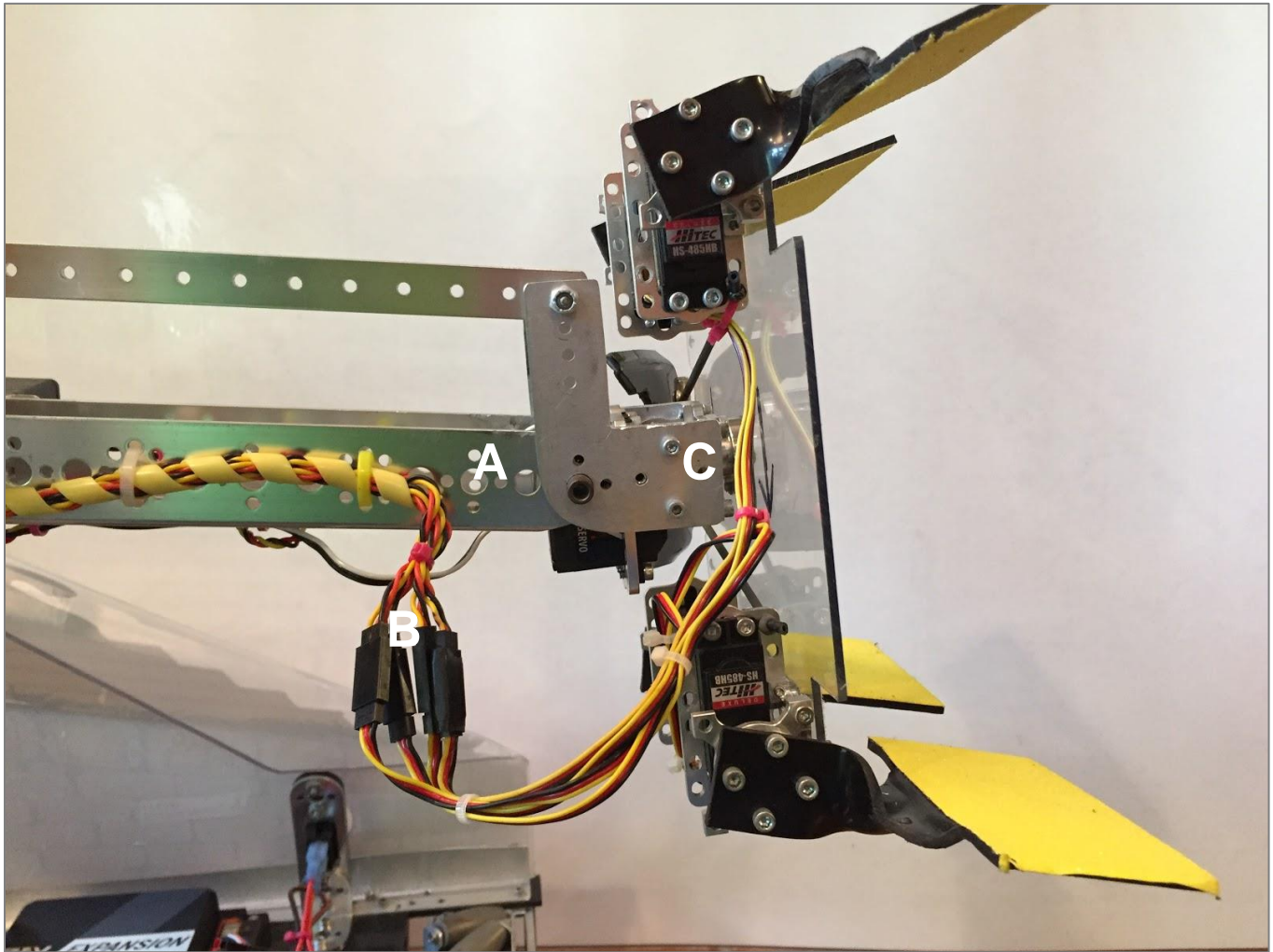

Figure 13: In-Line Connections

- A. Group of servo extension wires being used to accommodate a long arm.
- B. Each pair of mating servo connectors is firmly held together, either with a plastic shroud, or with electrical tape.
- C. Each side of the connector bundle is also stabilized with a zip tie, and a service loop has been created to permit the end-effector (Grabber) to rotate without pulling on the wires.

In some instances, the connectors on the ends of wires should also be secured in place. This is true for USB connections and some 12V power connectors. These connectors are susceptible to vibration or impacts, which may cause temporary or permanent loss of control.

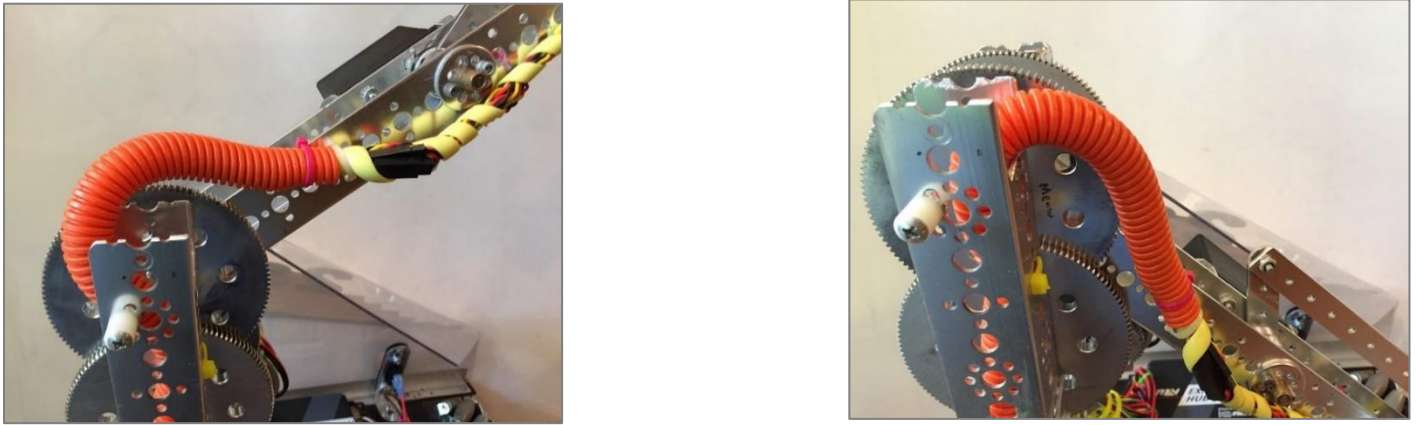

Figure 14: Wires Near Moving Parts

On this robot, many servo wires had to pass a rotating arm joint with several gears. To prevent loose wires from being pinched, the wires were bundled and then wrapped in a split sheath (orange). The sheath was anchored to the base at one end, and to the arm at the other end. A service loop of extra cable was created to allow full rotation of the arm without putting tension on the wires.

Connectors can be secured using zip ties or Velcro®, or teams can use 3D printed connector mounts. REV Robotics provides a USB connector restraint for its REV Expansion Hub.



Figure 15: USB Connector Mount



Figure 16: 3D Printed Connector Mount

If interconnected connectors are used to extend sensor/servo cables, or extend 12V DC power cables, the connectors should be firmly secured to each other. Electrical tape is often the simplest and most effective way to do this.

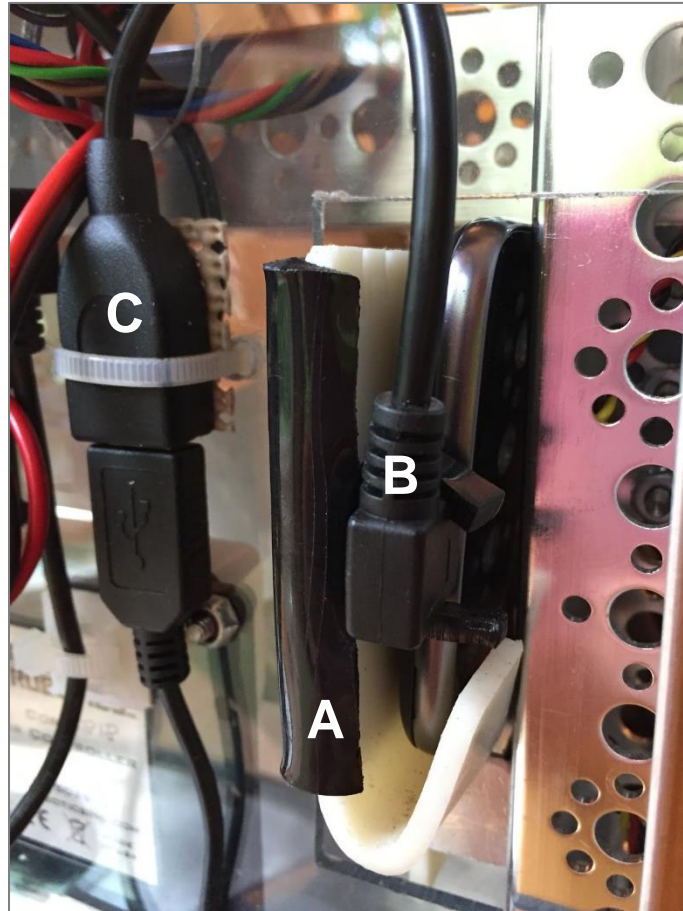

Figure 17: Stabilizing USB Cables

- A. The USB plug is constrained with the addition of a custom clamp.
- B. The use of a right-angled USB connector helps to keep the wiring near the robot structure.
- C. The female USB-A connector is zip-tied in place to prevent vibrations and to stop the cable from falling free when the phone is removed.

NOTE: Locating the phone next to a metal beam may not be optimal, as it may reduce wireless signal strength, but it was a compromise to achieve the desired camera location.

If wires need to be shortened or extended, soldering provides a robust yet compact splicing method. In this case, all soldered joints should be protected with heat shrink tubing. Slightly oversized tubing should be cut to length and placed over one wire before soldering the two wires together. Then a heat gun can be used to shrink the tubing to hold it in place.

Many sizes and colors of heat shrink tubing can be purchased from most electronics suppliers, such as Digi-Key or Mouser.

1.4. Wire Management

The most important step towards neat wiring is the implementation of proper wire management. Wire management involves bundling and routing wires along a defined path to the various electrical parts.

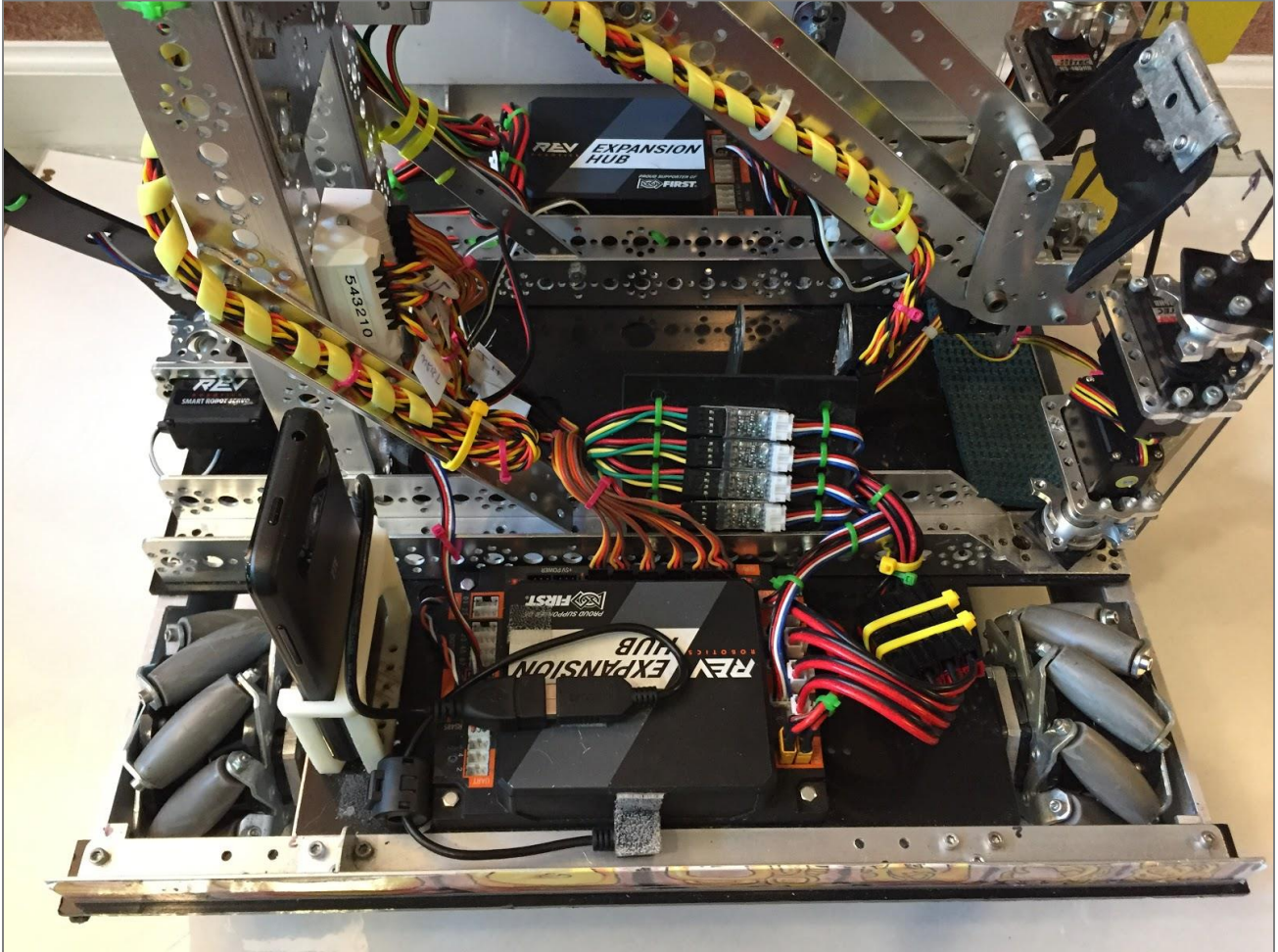

Figure 18: Multiple Wire Management Types

- A. This robot utilizes multiple actuators, requiring level converters, boosters, and wire extensions. Clutter is eliminated by organizing a logical flow through the robot, then bundling and constraining wire clusters wherever possible.
- B. Four encoder Level Converters are mounted to a plastic plate which is bolted to the main chassis. Wires to and from these converters are strain relieved on either side.
- C. Motor wires pass through Anderson PowerPole connectors and are bundled and restrained.

Servo PWM cables (and their extensions) are grouped in a flat bundle and routed to the white Servo Booster Module. Wires from the Booster Module are bundled and wrapped with a spiral sheath (yellow) which runs all the way up the arm support and to the rotating grabber. A service loop is created and attached to the arm on one side, and the grabber on the other side.

Keep the following tips in mind to ensure neat, robust wiring:

- Keep the wiring stationary.
- Protect the wiring.
- Where possible, make sure all cables are the correct length.
- Bundle cables together if they are running to a common destination.
- Use right-angle USB connectors if they keep wiring more compact.
- Use wire management hardware.
 - Self-adhesive cable tie mounts help attach wires to surfaces without holes.
 - Grommets protect wire from damage from sharp edges.
 - Wire sheaths allows teams to quickly protect at-risk wiring.



Figure 19: Wire Management Hardware

1.5. Wires on Moving Parts

Most robots have one or more components that move relative to the main drive chassis. This could be things like a pivoting arm, an extending collector, or a shooter turntable. When these components have motors and sensors attached, it is very important to ensure that the connecting wires can accommodate the movement. There are several precautions that can be taken to ensure that wires do not get pinched, twisted, or entangled.

Constraining wires is the first line of defense. An unconstrained wire is likely to get caught and pulled as one component moves past another. However, moving parts often need “extra” wire when they are fully extended or rotated, so it is important to plan this extra wire when the part is retracted. The extra wire should be formed into a “service loop”, which keeps wires bundled together, and provides a predictable movement. These bundled wires can be further protected by an expandable, spiral, or split sheathing. This sheathing serves as a flexible outer protector for the wire bundle as it moves near potential pinch/entanglement points.

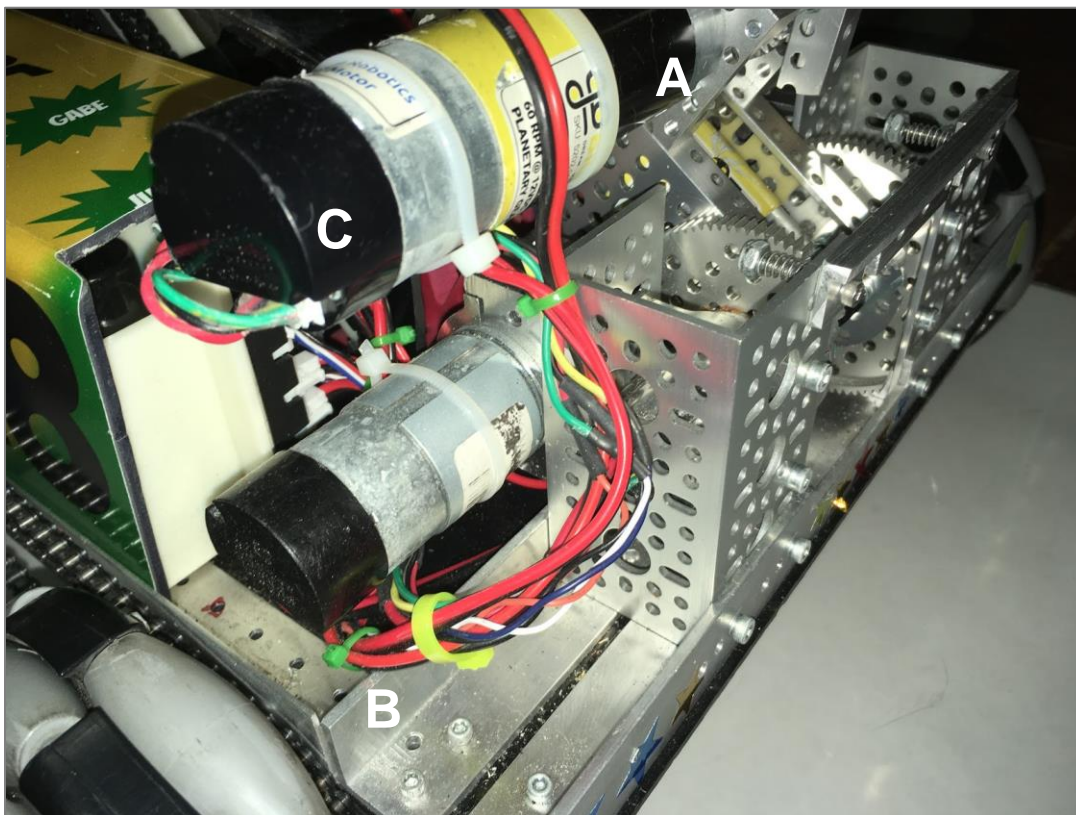

Figure 20: Wires Near Moving Parts

- A. The upper motor is mounted to a movable arm, which rotates relative to the robot chassis.
- B. Notice that the motor's power and encoder wires have been bundled (yellow and green zip ties) into a service loop.
- C. Anchored to the motors (white zip ties). This maintains control over the wires when the arm rotates and ensures that none are pinched.

1.6. Battery Security

The placement, connectors, and methods for securing the battery properly will ensure safety and enhance the life of the battery.

The battery is often one of the heaviest parts of the robot and its placement can have a dramatic effect on drivability and stability. A good rule of thumb is to place the battery as low as possible for stability. Omnidirectional drives require constant pressure on all wheels so position the battery to help with even weight distribution.

Since batteries need to be removed to be charged, extra thought should be given to how they are mounted in the robot. A loose battery can get caught in moving parts and be damaged or can tug on the battery connector and cause the robot to lose power. Since they are heavy, batteries tend to want to shake free as the robot maneuvers, so it is important to ensure that they are fixed in place. This can be achieved by creating a mechanical "receptacle" that snugly holds the battery in

place. They can also be restrained with Velcro attached to the battery and robot, or by using a Velcro strap to hold the battery against the frame.



Figure 21: Battery Security

- A. REV Robotics flat battery pack is mounted vertically next to an Expansion Hub.
 - B. A 3D printed container was created to loosely constrain the battery, and a Velcro strap was added to prevent the battery from bouncing out during robot deployment.
- NOTE: In the case of a Control Hub, this mounting method could block radio waves traveling to and from the Hub's wireless adapter.
- C. For security, the battery connector (yellow XT30 plug) is plugged into a mating connector on the robot, which is zip tied (yellow) in place.

Some teams use zip ties to secure their battery, but unless the team only has one battery, these zip ties will need to be cut and replaced each time the battery is removed to be charged. Consider using a method that can be “un-done” rather than replaced each time. If zip ties are used, make sure the ties are not overtightened to prevent damaging the internal connections of the battery.

Care should also be taken to make sure the mounting points for the battery do not puncture or break the insulation of the battery or battery leads. Ensure there are no sharp edges that can cut into the battery.

1.7. Battery Safety

Batteries are used to store energy, and so it is important to store and manage that energy safely. The following guidelines should be always used:

- For safety reasons, batteries should not be left unattended while charging. The charging process may cause faulty batteries to overheat and create a fire hazard.
- Be sure to protect the battery terminals while storing batteries. Do not store or transport batteries with other loose metallic items which could inadvertently cause a short circuit across the battery terminals.

- Under no circumstances should there be exposed ends on both battery wires. Bare wires that touch will short out and damage the battery and may create a fire hazard.

1.8. 12V Power Switch

A single 12V power switch is required on all FTC robots. Since quick access to this switch may be required by field personnel, it should be mounted in a readily accessible location. This will typically mean, near the exterior of the robot, facing outwards. However, the switch should be protected so that it cannot be turned off accidentally through contact with a field element or other robot. Here are some ways to achieve this:

- Do not mount the switch outside, or flush with, the chassis perimeter of the robot.
- Angle the switch upwards to prevent contact from basic robot movement.
- Place the switch behind a cover plate or side shield with a small opening for manual operation.
- Ensure that game pieces cannot fall onto the switch.

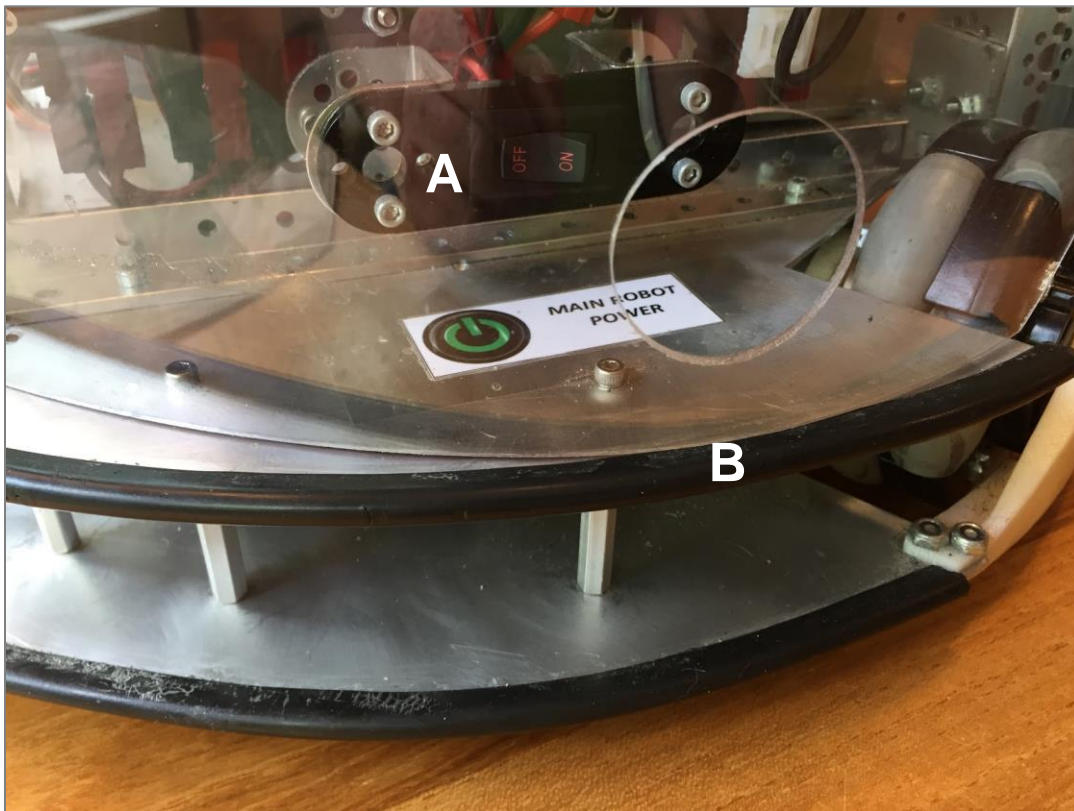

Figure 22: Power Switch Placement, Side Shield and Chassis Insulation

- A. Here the power switch has been mounted inside the robot frame using TETRIX hardware, facing outwards for easy operation. The switch is behind a transparent (PETG) side shield, with a hole cut for easy access. This protects the switch from accidental contact, but still provides FTAs (FIRST Technical Advisor) with great visibility and access. Notice the approved power switch label.

- B. Side shields are also used to protect internal electronics from entanglement and possible ESD events. Also note that black rubber edge guards protect the circular chassis plates from external electrical contact.

1.9. 12V Power Distribution

To enable full functionality of the robot's electronics, it is important to have stable 12V power, and sufficient current capacity for all 12V wiring. FTC approved 12V power components are designed with appropriate connectors and wire gauges to support a typical robot. A simple REV power system would supply 12V from the fused battery, through a power switch into a REV Expansion Hub. Power would be daisy chained out of the parent hub into an optional child hub.

However, for robots that have high current loads (from many motors) or have a larger number of 12V components (like Servo Power Modules or SPARK mini motor controllers), it may be desirable to utilize a 12V power distribution bus. A power bus takes a single input power feed and splits it into several 12V outputs, each can power a dedicated device instead of daisy chaining the power from one component to the next.

A power bus can be created by building a custom wiring harness or by purchasing a commercial power distribution block, like the REV XT30 Power Distribution Block or the Anderson Powerpole Power Distribution Block from Powerwerx (shown below).



Figure 23: Power Distribution Blocks

1.10. Protective Side Shields

Most FTC games involve Robot-to-Robot and Robot-to-Game element contact. This contact may be intentional or accidental, and it can sometimes extend into the inner workings of your robot. To prevent damage or interference (such as ESD), it is desirable to prevent external objects from being able to contact critical internal electrical components.

One popular way to prevent undesired intrusion is to add one or more side-shields to your robot. These should be constructed from non-conductive materials. They can also be used to add strength or industrial design elements to your robot. Shields are also useful for preventing loose, game scoring elements (balls, blocks, etc.) from falling into your robot and counting against any maximum holding allowance.



Figure 24: Side Shields

In this example, side shields serve many functions:

- They protect the inner workings of the robot from contact from other robots.
- They prevent game pieces (Glyphs) from getting caught inside the robot.
- They protect the power switch (lower left).
- They provide a surface for theme decoration, and team identification.

Durable, clear, plastic, side shields can be constructed using polycarbonate, PVC or PETG to allow internal visibility for status lights or mechanisms.

NOTE: Plexiglass (Acrylic) is a commonly available clear plastic, but it is quite brittle, so it may not be suitable for protective shields.

1.11. Wi-Fi Considerations

The Robot Controller phone and the Control Hub use a wireless radio to communicate with the Driver Station. Choose the placement of the phone and hub with the following considerations:

- It is important to protect the phone and Control Hub from robot-to-robot contact. Attach the phone or Hub to the robot in a place protected from physical impact.
- Choose a location on the robot where the radio waves that are traveling to or from the phone or Control Hub will not be blocked/reflected by large pieces of metal or by a 12V battery or a motor.
- Choose a location on the robot where the radio waves that are traveling to or from the phone or Control Hub will not be disrupted by electromagnetic interference that could potentially be generated by a 12V DC motor.
- Reduce the risk of an electrostatic shock between the phone and the metallic frame of the robot by mounting the phone on an insulator, like plastic or wood.
- Make sure the phone is easily accessible for charging, programming, and emergencies.
- Make sure the phone sits so the camera is available for Vuforia, if needed.



Figure 25: Phone Mounting

- A. The Robot Controller phone is held in position using 3D printed mount.
 B. The mount is bolted to plastic base plate keeping the phone separated from all metalwork.
 C. This mount is from Thingiverse. USB connector is strain relieved by the 3D printed mount.
 D. A two-part cable is used to connect the phone to the REV Expansion Hub. This permits the two devices to be frequently disconnected without wear and tear on either device.
 E. A ferrite choke is attached to the USB cable and held in place with Dual-Lock. The Expansion Hub is also bolted to a plastic base plate to provide additional ESD immunity.

1.12. ESD Mitigation

An electrostatic discharge (ESD) event occurs when a charged object (like a robot) discharges to a neutral (no charge) or oppositely charged object. Because of the high voltages involved (up to tens of kilovolts), ESD events produce extremely high electrical current transients. For more details on the cause of ESD's, refer to FIRST's Document: [White Paper: Analysis ESD Mitigation by Eric Chin](#)

When a serious ESD event occurs, the operation of the control system may be disrupted momentarily, or even for an entire match. There are several best-practices recommended to minimize the occurrence and impact of ESD's. These are as follows:

1.12.1. Grounding

Grounding the electrical system to the robot's frame will reduce the risk of shock between the robot's frame and the control system electronics. The grounding wire helps keep the electronics at the same potential as the frame, preventing arcs between the two systems. In addition to insulating the electronic components of the control system from the frame, grounding the electronics to the frame will safeguard against an ESD event.



Figure 26: Grounding Wire

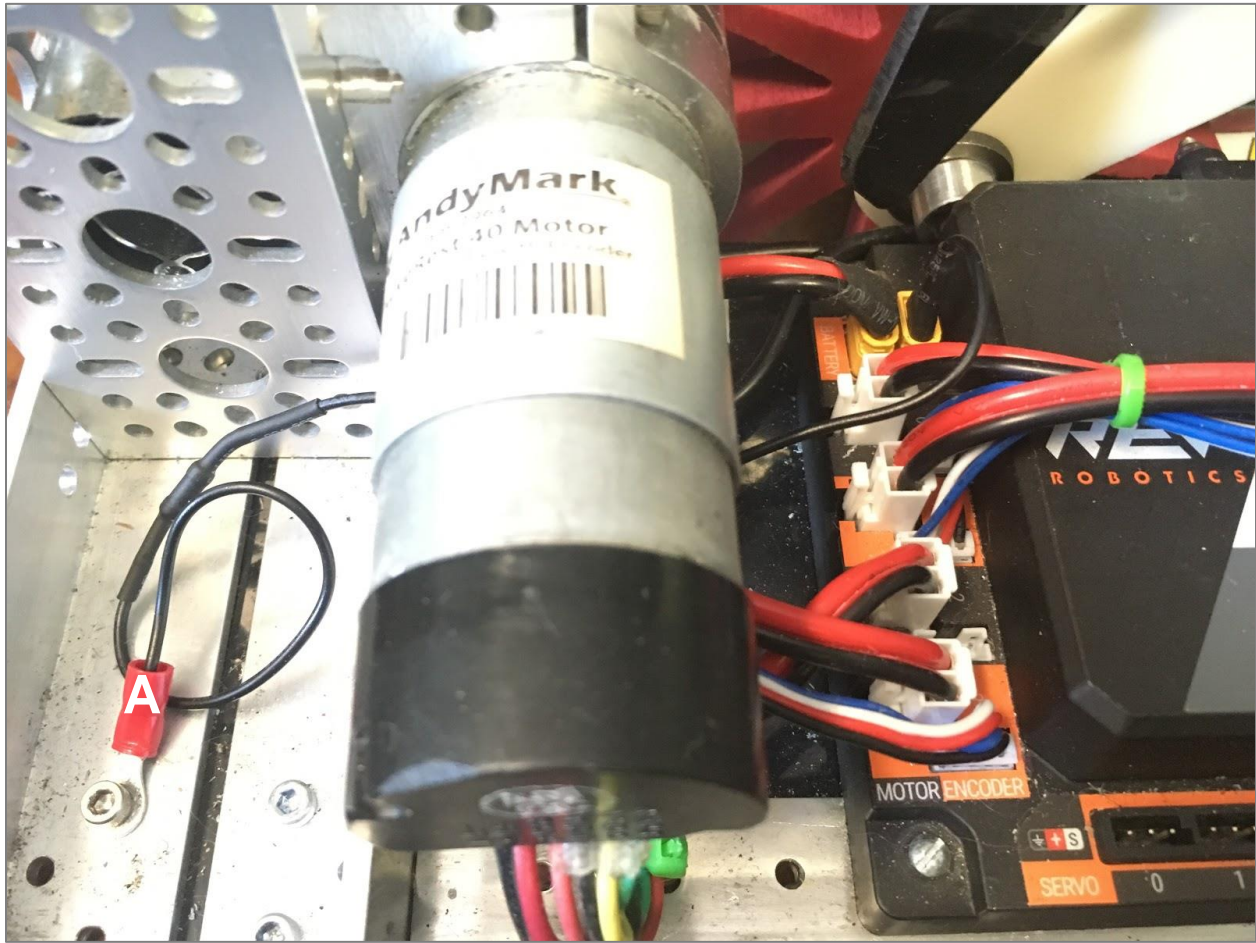

Figure 27: Grounding Strap

- A. The grounding wire is plugged into the last Expansion Hub in the power chain and bolted to a metal component of the robot's chassis.

The Game Manual requires using a *FIRST*-approved, commercially manufactured cable:

- It has an appropriately sized inline resistor, which prevents excessive current from flowing through the frame.
- It has a keyed connection designed to prevent a user from inadvertently connecting a hot (12V) line to the frame of the robot.

1.12.2. Ferrite Choke

These snap-on or built-in components block spikes of current, like those seen in an ESD event. Use them on sensor cables, encoder cables, and servo cables to reduce the risk of damage and/or

disruption to electrical components. It is best to use high-quality, shielded, USB cables with built-in or external ferrite chokes to help reduce interference on the line from the motors and electrostatic discharges. Since the chokes may be heavy, they should be restrained to prevent them from putting undue mechanical stress on wiring.



Figure 28: Ferrite Chokes

1.12.3. Placement of Wires

The Control System's electronics may have exposed metal or poor insulation. If these components are placed too close to the metal frame and a charge accumulates on the frame, an ESD can occur.

For example, the 4-wire sensor cables that are used by the REV Robotics Expansion Hub and Control Hub have plastic connectors that are poorly insulated. If a charge accumulates on the metal frame of the robot and the end of the sensor cable is placed too close to the frame, a shock can occur, and this shock can disrupt or even damage the I2C port of a Hub.

Similarly, some servo extension cables have exposed portions of metal that could be vulnerable to ESD unless properly isolated or insulated.

Moving these vulnerable areas of the electronics system away from the frame (with an air gap greater than 3/8" or 10 mm) can help reduce the risk of an ESD disruption.

Using electrical tape to insulate these areas can be equally effective and may be easier.

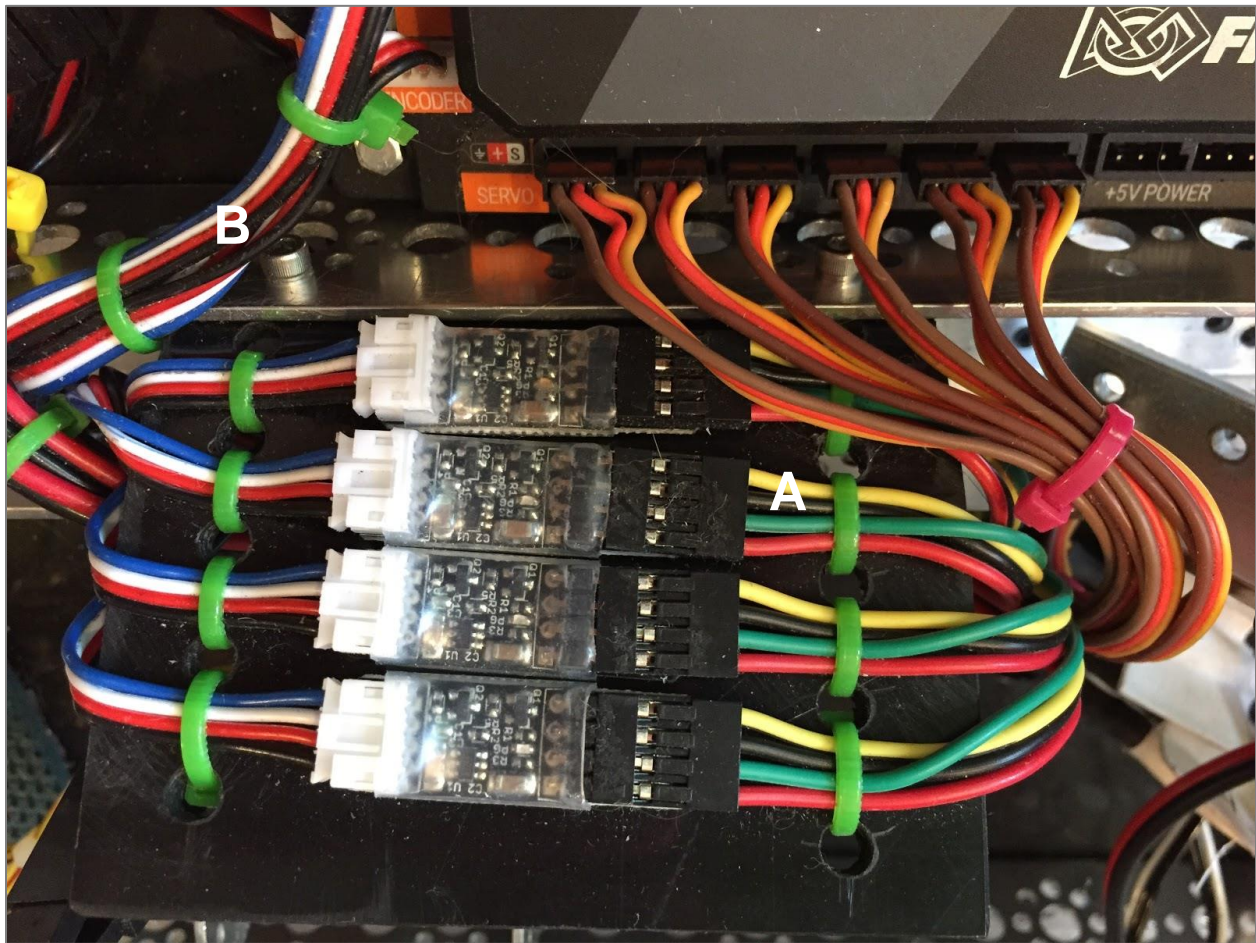

Figure 29: Level Shifters

These level shifters are being used to interface to the NeveRest Motor Encoders.

- A. Four motors require four encoders. The shifter modules have been mounted to a plastic bracket to minimize ESD events, and then bolted to the chassis.
- B. Wires leading to and from the modules have been restrained to provide strain relief to the connectors, and the cables are bundled to consume minimal space.

1.12.4. Avoid External Exposed Metal

Covering the conductive exterior (perimeter) parts of a robot with a non-conductive material reduces the risk that they will touch a conductive object at a different electrical potential and trigger an ESD event. Wooden bumpers, electrical tape, and other non-conductive coatings are all effective.

1.12.5. Wheel Considerations

Teams should research the pros and cons of different wheels. Certain materials and wheel designs can affect the accumulation of static charge. Mecanum wheels, for example, may produce more static than other types of wheels.

1.13. Driver Station

Not all wiring issues are on the robot. The driver station also has several components that must have reliable connections to ensure proper operation. Many teams who bring their phones and game controllers to the competition field as a handful of loose pieces will see problems with loss of control before or during a match. If a game controller cord gets tugged, it may cause a brief USB disconnect which will cause the controller to stop communicating with the robot. This can cause loss of control of the robot at a critical time.

To ensure stable and consistent operation it is recommended to mount the Driver Station phone, USB hub and Game Controller connectors to a rigid base plate. This base plate should be non-metallic (wood or plastic), and it can also provide an easy way to store the game controllers. Items can be attached to the base plate with Velcro®, zip ties, Dual Lock, or even hot glue. All connectors should be strain relieved.

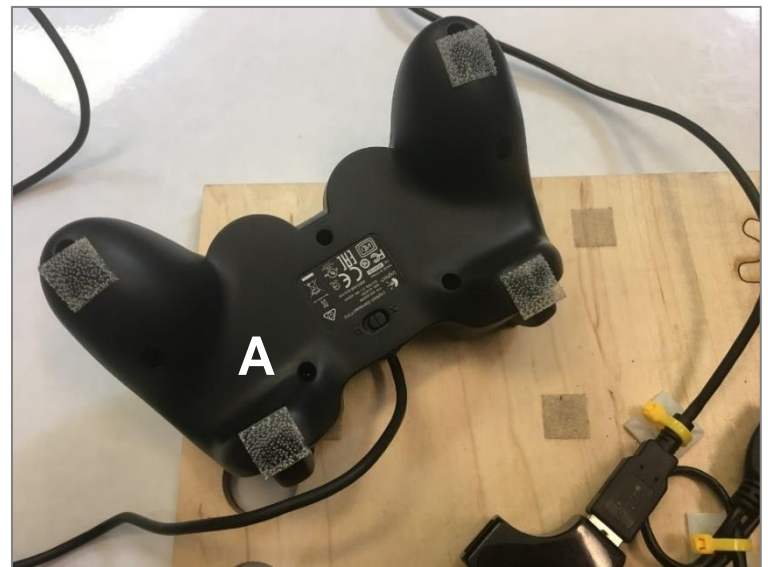

Figure 30: Driver Station

- A. The game controllers are attached to the board using 3M Dual Lock, but any hook and loop system could be utilized.
- B. The Micro USB connector entering the phone is strain relieved. It has enough free wire to be easily unplugged to charge the phone.
- C. The phone holder, USB hub and connectors are all anchored in place to prevent them from disconnecting due to jostling.
- D. These images show a driver station constructed from a thin sheet of plywood (any non-metallic could be used).

2. Adapting Power Systems

2.1. Types of Wires and Connectors

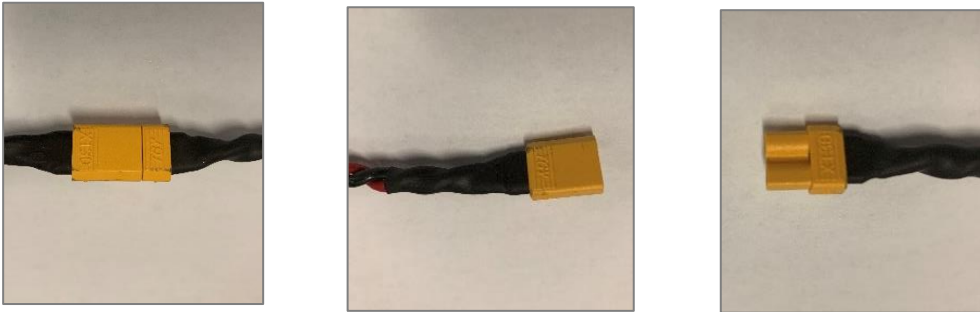

Figure 31: XT30 Connectors (Male and Female)

REV Robotics: The REV system uses XT30 connectors for the power wires. These connectors are used in the RC vehicle industry and are designed to withstand repeated connect and disconnect cycles. It is not necessary to replace these connectors with Anderson PowerPoles. However, there have been credible reports of occasional disconnects between the XT30 connectors provided with the REV Robotics hardware.

If you suspect that you might have a loose XT30 connection, then conduct a careful physical inspection of the connection. Check to make sure the connectors fit snugly together and there is a slight amount of retention between the connectors when you try to pull them apart. Also check to make sure that power is not disrupted when the ends of the power cables that connect through the XT30 connectors are jiggled. If you do find a loose connection, replace the bad cable, or contact REV Robotics if the bad connector is mounted on the Hub.

If you prefer to use Anderson PowerPoles as your primary connectors, then you can attach an XT30/Anderson PowerPole converter cable to the Hub and strain relieve it properly. Once this converter is plugged into the Hub, it can be left in place, and the battery can connect or disconnect using the Anderson PowerPole connection. This will reduce the wear experienced by the XT30 connectors.

Warning: Do not reverse the polarity of the input DC power. Although the REV Robotics Hubs have built-in reverse polarity protection, there have been credible reports of damaged Hubs when reverse polarity power is applied.



Figure 32: Reversed Polarity

2.2. Making an Adapter

Teams may wish to replace the connectors on their batteries and install more reliable connectors in their place. If teams choose to do this, the old connectors can be useful.



Figure 33: Anderson PowerPole and XT30 Connectors

When removing the unwanted connectors from the battery, do not cut the wires flush with the end of the connector. Instead, leave a 1/2" length of wire attached to the connector.

2.3. Installing Anderson PowerPoles

The following steps explain how to install Anderson PowerPoles on a battery (TETRIX, REV, and current MATRIX). The same steps can be modified to install Anderson PowerPoles on any wire.

1. Remove the fuse from the battery.



Figure 34: Fuse Removal

2. Cut one of the wires close to the attached Tamiya connector. Do not cut too close to the battery or the fuse housing, that will make installation difficult or impossible.
3. Strip the wire to the Anderson PowerPole specs.



Figure 35: Strip the Wire

4. Crimp the connector to the wire. Make sure the wire is in the proper orientation before doing this -- the PowerPoles need to connect properly.



Figure 36: Crimped Connector and Red Housing

5. Snap on the plastic housing.
NOTE: Attach red housing to the positive wire, and black housing to the negative wire.
6. Repeat steps 2 through 5 on the remaining wire.
7. Slide the side locking mechanism of the adjacent red and black housing.

NOTE: Red positive raised side should slide into the black negative recessed side.



Figure 37: Proper Orientation of Housing

8. Slide and snap red housing to the other red housing, repeat for the black housings.
9. If applicable, reinsert the fuse.
10. Repeat the procedure on the battery charger.

3 Adapting Logic Levels

3.1. Level Shifters

There are two voltage levels commonly used for logic on integrated circuits (like the chips in a REV Robotics Expansion Hub): 5V and 3.3V. The REV Expansion Hub uses 3.3V logic levels, but Modern Robotics devices work using 5V logic levels. If you would like to use 5V Modern Robotics I²C sensors with the REV Robotics Expansion Hub, then you will need:

- Logic level converters (also known as Level Shifters) to convert the signals to and from the sensor.
- REV Robotics Sensor Adapter Cable (REV-31-1384) to connect the 5V sensor to the logic level converter.
- A complete explanation can be found in the [REV Robotics Expansion Hub Getting Started Guide](#)

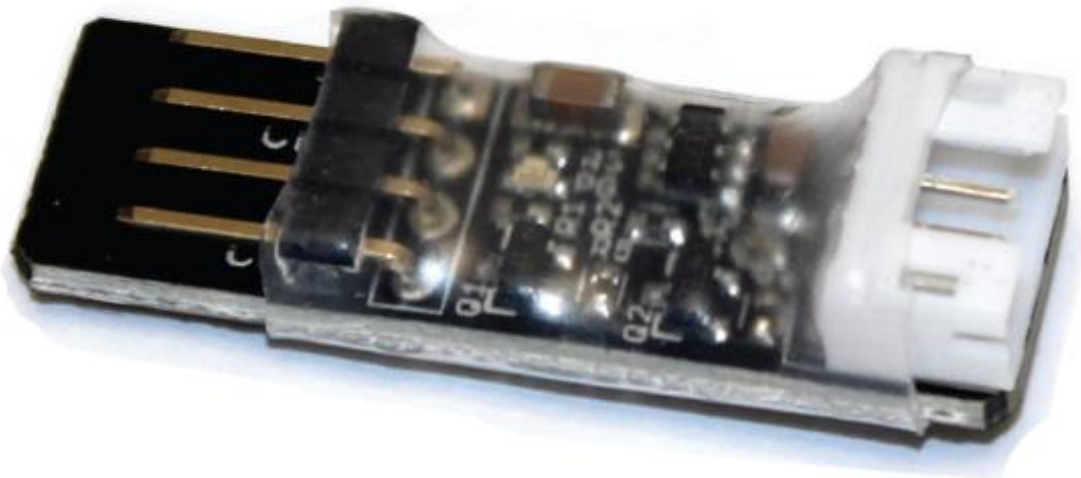

Figure 38: Logic Level Converter

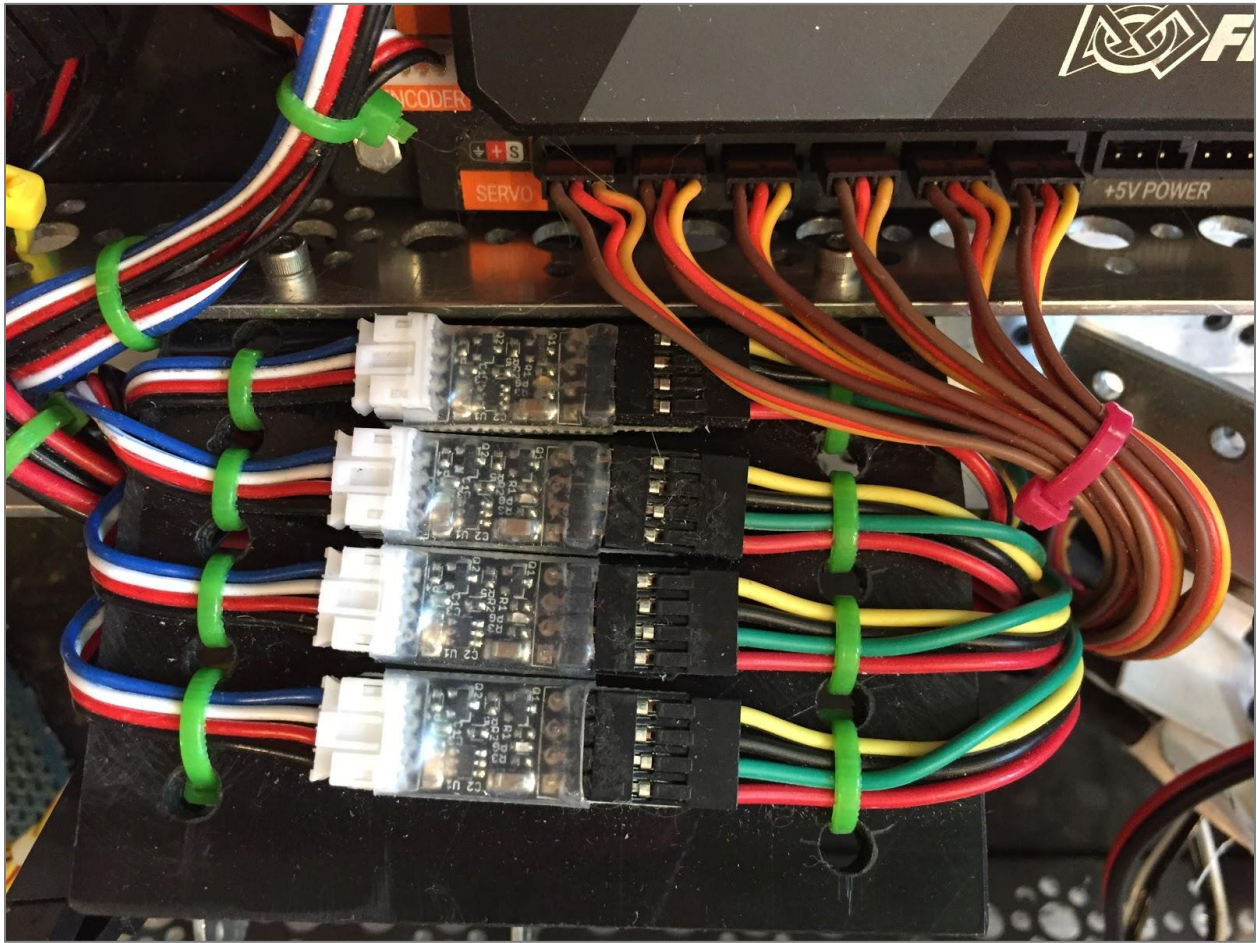

Figure 39: Level Shifters

These level shifters are being used to interface to the NeveRest Motor Encoders.

4. Common Problems and Troubleshooting:

4.1. Connection Issues

- Hardware Issues
 - Before wiring a robot, make sure to inspect the ports on all the modules. It is possible to damage the pins in the module ports. If this is the case, do not use the module. It should be sent back to the manufacturer for repairs.
- Reversed Wires
 - The Expansion Hub and the Control Hub have three color-coded symbols that align the servo wire colors.
 - Be sure to match the black, red, and white wires with the color-coded symbols on the Hub.
 - Check the connection on servo extensions and splitters too.



Figure 40: Color-coded Symbols

4.2. Hub and Phone Communication Issues

The signals that pass between the Android phone and the controllers are sensitive to interference. If a motor power wire or servo wire is routed next to a USB cable, it is possible to induce a stray signal that can lead to intermittent problems.

5. Additional Resources

Careful incorporation of the solutions and wire management tips in the previous four sections should ensure more robust electrical system performance and increase robot reliability. For teams looking to further increase their wiring knowledge, the following may be useful:

- [NASA Guide to Crimping, Interconnecting cables, Harnesses, and Wiring](#) Basic wiring instructions that are provided by [REV Robotics](#) for its [Expansion Hub Control System](#).
- FIRST also has several resources for teams looking for more information on the Android based technology: <https://www.firstinspires.org/resource-library/ftc/robot-building-resources>

Appendix A – Resources

Game Forum Q&A

<https://ftc-ga.firstinspires.org/>

Anyone may view questions and answers within the *FIRST*® Tech Challenge game Q&A forum without a password. To submit a new question, you must have a unique Q&A system username and password for your team.

Volunteer Forum

Volunteers can request access to role specific volunteer forums by emailing FTCTrainingSupport@firstinspires.org. You will receive access to the forum thread specific to your role.

FIRST Tech Challenge Game Manuals

Part 1 and 2 - <https://www.firstinspires.org/resource-library/ftc/game-and-season-info>

FIRST Headquarters Pre-Event Support

Phone: 603-666-3906

Mon – Fri

8:30am – 5:00pm

Email: Firsttechchallenge@firstinspires.org

FIRST Websites

FIRST homepage – www.firstinspires.org

[FIRST Tech Challenge Page](#) – For everything *FIRST* Tech Challenge.

[FIRST Tech Challenge Volunteer Resources](#) – To access public volunteer manuals.

[FIRST Tech Challenge Event Schedule](#) – Find *FIRST* Tech Challenge events in your area.

FIRST Tech Challenge Social Media

[FIRST Tech Challenge Twitter Feed](#) - If you are on Twitter, follow the *FIRST* Tech Challenge Twitter feed for news updates.

[FIRST Tech Challenge Facebook page](#) - If you are on Facebook, follow the *FIRST* Tech Challenge page for news updates.

[FIRST Tech Challenge YouTube Channel](#) – Contains training videos, game animations, news clips, and more.

[FIRST Tech Challenge Blog](#) – Weekly articles for the *FIRST* Tech Challenge community, including outstanding volunteer recognition!

[FIRST Tech Challenge Team Email Blasts](#) – contain the most recent *FIRST* Tech Challenge news for teams.

Feedback

We strive to create support materials that are the best they can be. If you have feedback about this manual, please email firsttechchallenge@firstinspires.org. Thank you!